

Compact Hemispheric Camera for Ceilings



MOBOTIX c25
MX-c25

- Includes MxAnalytics video analysis tools out-of-the-box
- Recording on internal MicroSD card (SDXC)
- Sound recording using integrated microphone
- Speaker can be attached using accessories (e.g. MOBOTIX ExtIO)
- Sensors for temperature, illumination, shock detection integrated
- Installation is as simple as installing a ceiling spotlight

MOBOTIX 5MP camera for unobtrusive indoor applications, available as Day or Night version with L12 lens (Hemispheric) or L23 (92°)
More information on www.mobotix.com > Products > Hemispheric c25

32.254-002_EN_05/2015

c25 Standard Delivery

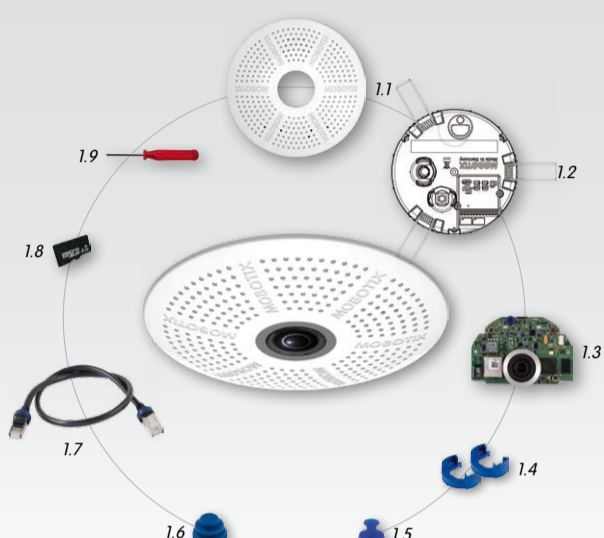

Item	Count	Part Name
1.1	1	Housing (installed)
1.2	1	Back plate with spring clips (installed)
1.3	1	Main board with lens L12 or L23 (installed)
1.4	2	Bayonet catch, blue (installed)
1.5	1	USB plug, blue (installed)
1.6	1	Ethernet plug, blue (installed)
1.7	1	Ethernet patch cable, 50 cm/19.7 in, black
1.8	1	MicroSD card (SDXC, installed)
1.9	1	Disassembly tool

Connection and Initial Operation of the c25



For information on **connecting** the c25, please see the Q25M Camera Manual, Section 2.9, «Network and Power Connection, Additional Cables».

Regarding the **initial operation** of the c25, please see the Q25M Camera Manual, Chapter 3, «Initial Operation» and follow the instructions for ceiling-mounted cameras.

Use a suitable device for operating the camera keys (e.g., an opened paper clip).



Installing the c25

Use the drilling template on the back for this purpose (red circle) or draw a circle with 105 mm/4.13 in diameter for the cut-out. Cut out the hole for the camera, then guide the Ethernet cable and any other cables you want to attach to the camera through the hole.

1. Connect the cables

Insert the cables into the appropriate connectors and fasten them using the blue bayonet catches.

Make sure that the camera points into the desired direction: The icon on the back (black arrow) shows the "up" direction of the image.

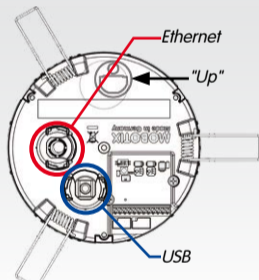

2. Install the c25

Press the spring clips back and insert the c25 into the hole for the camera. The spring clips will snap outwards, thus firmly holding the camera in place.

Make sure that you only press back the spring clips as shown in the image. Do not press them back any further as the springs may snap out of their fixtures otherwise.



Inserting/Exchanging the SD Card

All camera models can use the integrated MicroSD card (SDXC) to record video data. In order to exchange the MicroSD card, please proceed as outlined in the following instruction. For information on reliable SD cards, please see the MOBOTIX website www.mobotix.com > Support > MX Media Library > Planning in the document *MicroSD Card Whitelist for MOBOTIX Cameras*. If the camera has not yet been installed, skip step 1.

Caution: In order to avoid damage from electrostatic discharge, you should touch a grounded device before opening the housing of the camera (e.g., the blank metal at the back of a computer). This will remove any static electricity that may have built up.

1. Remove camera, remove cables

Pull the camera from its position by gently pulling the camera downward on one side, then the other side. **Take care to NOT let the spring clips snap forward (this may hurt you!).** Remove all cables that are attached to the connectors on the back side.



2. Locate the locks

In order to remove the back plate, you will need to push the delivered disassembly tool (item 1.9) into the three holes on the back one after the other to release the locks (see red circles in figure).

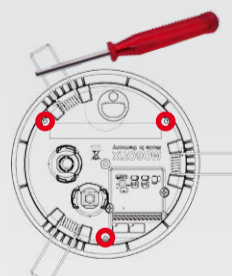

3. Remove back plate

Insert the disassembly tool into a lock and press firmly until you feel a perceptible resistance **1**.

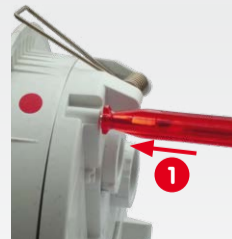

Gently push against the nearest spring clip to push the lock out of its seat and to lift the back plate from the housing **2**.



Repeat the process for the two other locks and cautiously lift the back plate from the housing.

4. Remove/insert SD card

If a MicroSD card has been installed, gently press with your finger as indicated by the arrow until you hear a **click**. Then release the SD card. The card is protruding slightly and can be easily removed.

Insert the new MicroSD card and gently press with your finger as indicated by the arrow until you hear the **click**.



5. Attach back plate

Make sure that the SD card is properly locked in place, since the card can be damaged otherwise. Begin by inserting the wide lock (next to the SD card) into the camera housing as shown. From the factory, the lock and the corresponding slot are highlighted by **color mark**.

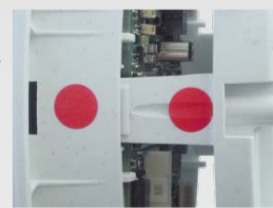

Make sure that the two other locks are also properly positioned, then press the back plate into its seat until you hear all three locks click into place.



6. Re-connect the cables

Insert the Ethernet cable and – if installed – the USB cable into the corresponding sockets and secure the connectors using the blue bayonet catches.



Press the spring clips back and insert the camera into its original mounting position (see «Installing the c25»).

To finish, make sure that the camera image is properly aligned: If required, cautiously turn the camera to adjust image alignment.

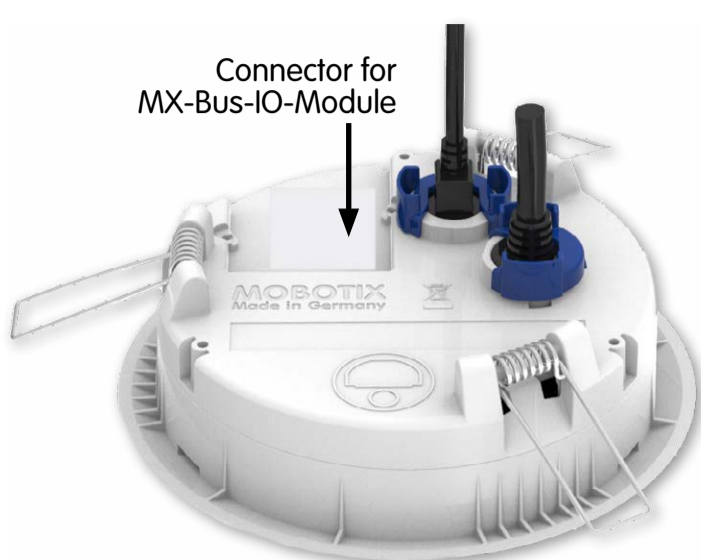
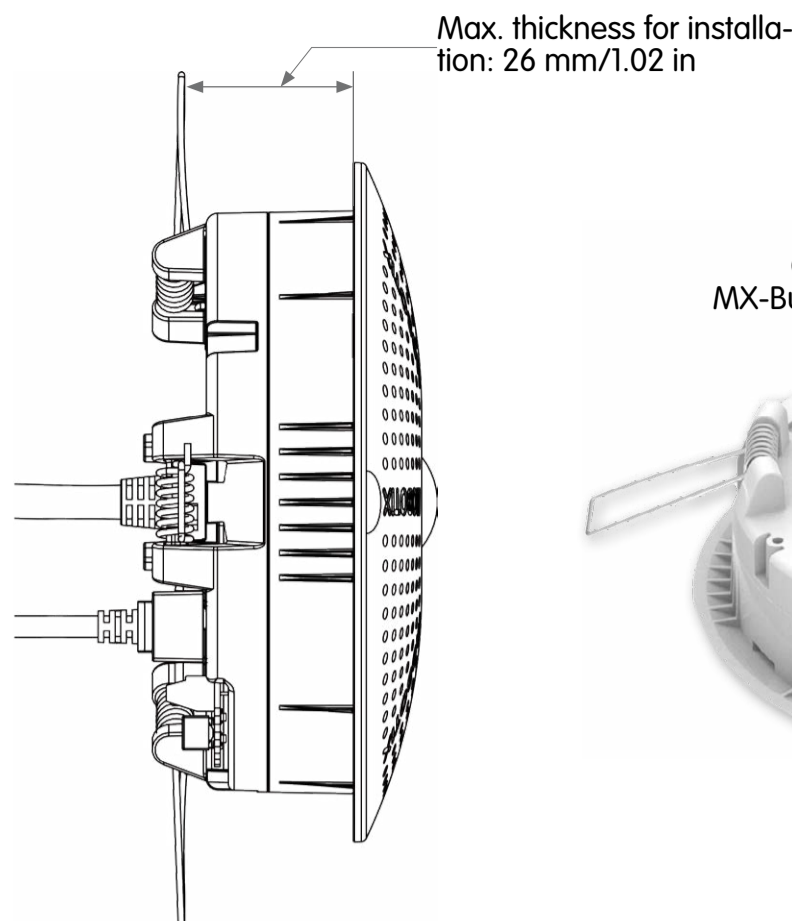

Important Notes

Safety Warnings

- This product must not be used in locations exposed to the dangers of explosion.
- Make sure that you install this product as outlined in the installation instructions above.
- When installing this product, make sure that you are only using genuine MOBOTIX parts and MOBOTIX connection cables.
- Only install this product in suitable, solid materials that provide for a sturdy installation of the fixing elements used.
- Electrical systems and equipment may only be installed, modified and maintained by a qualified electrician or under the direction and supervision of a qualified electrician in accordance with the applicable electrical guidelines. Make sure to properly set up all electrical connections.
- When attaching modules to the USB connector, the **power consumption of all attached modules must not exceed 1 W**.
- Due to the high performance of the c25, the area of the image sensor **can get quite hot**, especially when the ambient temperature is also high. This does not affect the proper functioning of the camera in any way. This camera must not be installed within the reach of persons.

- Make sure the power supply to the camera is disconnected before opening the camera housing (e.g., when exchanging the SD card).
- MOBOTIX products include all of the necessary configuration options for operation in Ethernet networks in compliance with data protection laws. The operator is responsible for the data protection concept across the entire system. The basic settings required to prevent misuse can be configured in the software and are password-protected. This prevents unauthorized parties from accessing these settings.
- Make sure that the operating temperature of 0 to +40 °C is not exceeded.

Legal Notes

You must comply with all data protection regulations for video and sound monitoring when using MOBOTIX products. Depending on national laws and the installation location of the c25, the recording of video and sound data may be subject to special documentation or it may be prohibited. All users of MOBOTIX products are therefore required to familiarize themselves with all valid regulations and comply with these laws. MOBOTIX AG is not liable for any illegal use of its products.

Technical Specifications

Since the c25 is identical to the Q25M for the most part, the technical data listed in the Q25M Camera Manual in Section *Technical Data* also applies to this product. You can find the Q25M Camera Manual as a PDF file on www.mobotix.com > Support > Manuals.



c25 (Differences Compared to Q25M)	
Lens Options	L12 (180° horizontal angle of view) L23 (92° horizontal angle of view)
Audio features	Microphone is always installed and activated, speaker depending on variant
Interfaces	Ethernet 10/100, IPv4/IPv6, MiniUSB, MxBus and inputs/outputs using optional accessory
Power Consumption	Typ. 4 W
Operating Conditions	IP20 (DIN EN 60529) 0 to +40 °C (DIN EN 50155)

c25 (Differences Compared to Q25M)	
Max. thickness for installation	Spring clips properly clamp down on materials from 1 to 26 mm/0.04 to 1.02 in
Dimensions	Outside diameter 120 mm/4.72 in, total height 51 mm/2.01 in with L12, 56 mm/2.21 in with L23, height installed 15 mm/0.59 in with L12, 20 mm/0.79 in with L23, rec. min. installation depth 55 mm/2.17 in
Materials	Housing: PBT GF30
Weight	approx. 212 g

Dimensions/Drilling Template

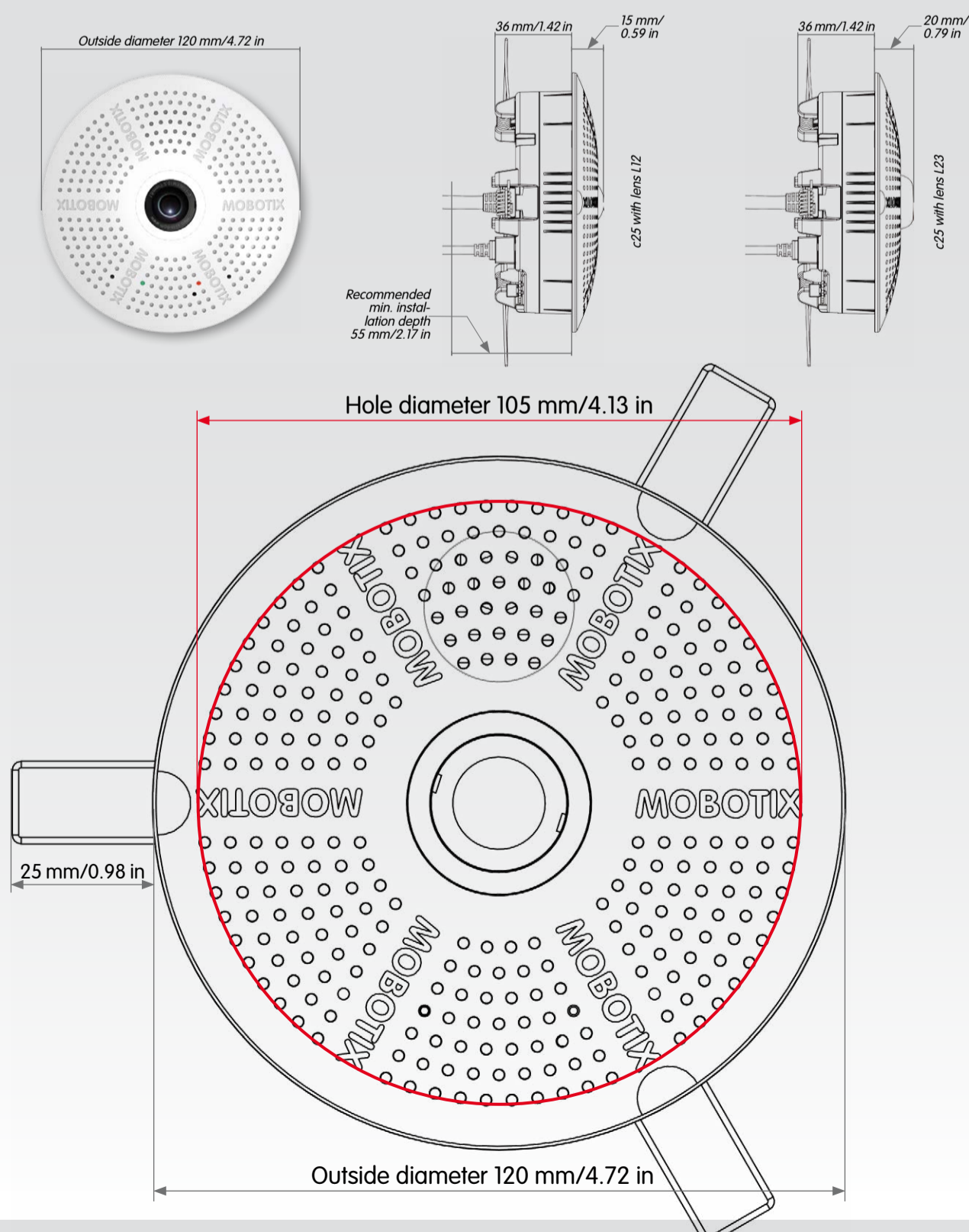

Innovations – Made in Germany

The German company MOBOTIX AG is known as the leading pioneer in network camera technology and its decentralized concept has made high-resolution video systems cost-efficient.

MOBOTIX AG • D-67722 Langmeil • Phone: +49 6302 9816-103 • Fax: +49 6302 9816-190 • sales@mobotix.com